

VUE ARRIÈRE

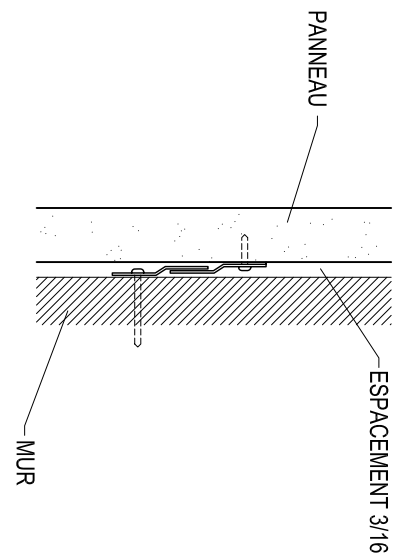

DÉTAIL D'ANCRAGE AU MUR
ECH: 3" = 1'-0"

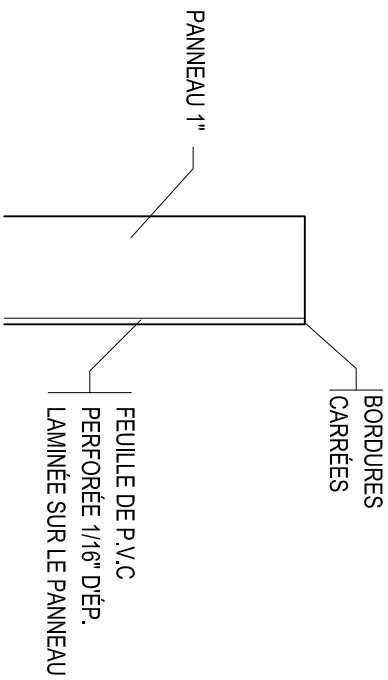

TOTAL 1 1/16 DÉP.

**DÉTAIL DU PANNEAU
SANS TISSU VUE LATÉRALE**
ECH: 6" = 1'-0"